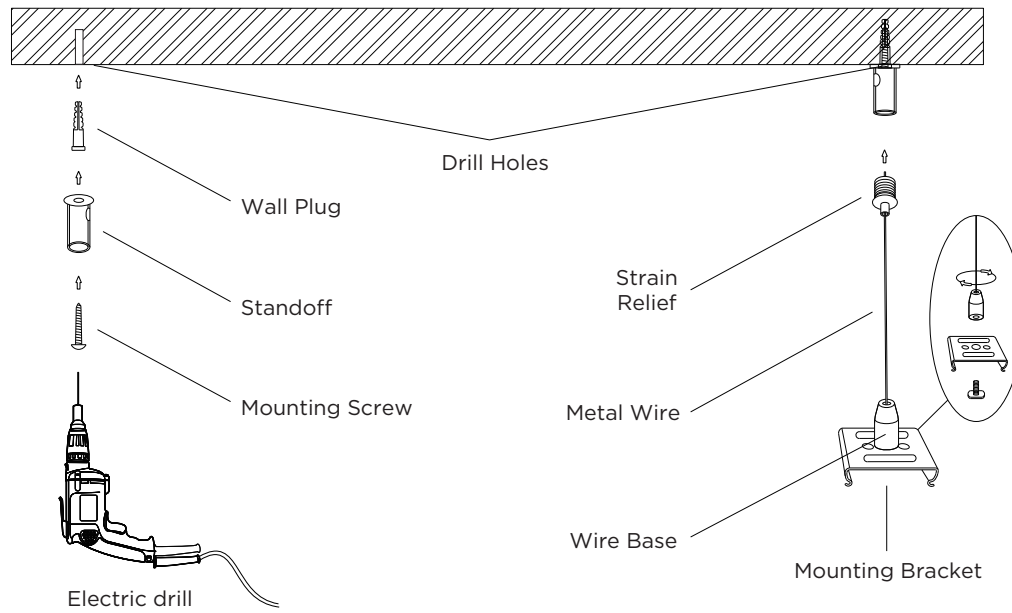
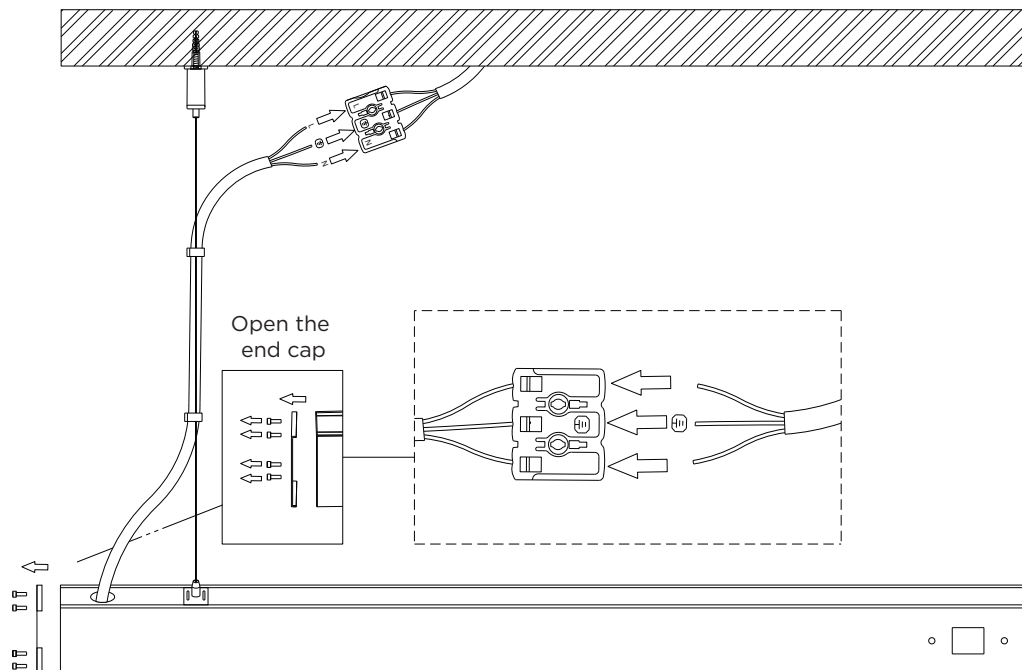

1**CEILING INSTALLATION**

Left: Mark the positions on the ceiling. Drill the holes to the plug's depth. Insert the wall plug flush with the surface. Align the standoff and drive the mounting screw through it into the wall plug.

Right: Screw the wire base into the mounting bracket, insert and screw the strain relief into the installed standoff. Set the cord length and tighten the strain-relief so the cable can't pull.

2**POWER CONNECTION**

Open the end cap, take out the terminal block from LED Fixture, press the terminal block, and insert the three-core main wire with the core removed into the corresponding holes of the terminal block. Connect the other end of the three-core main wire to the mains power line on the ceiling.

3

LIGHT TO LIGHT CONNECTION

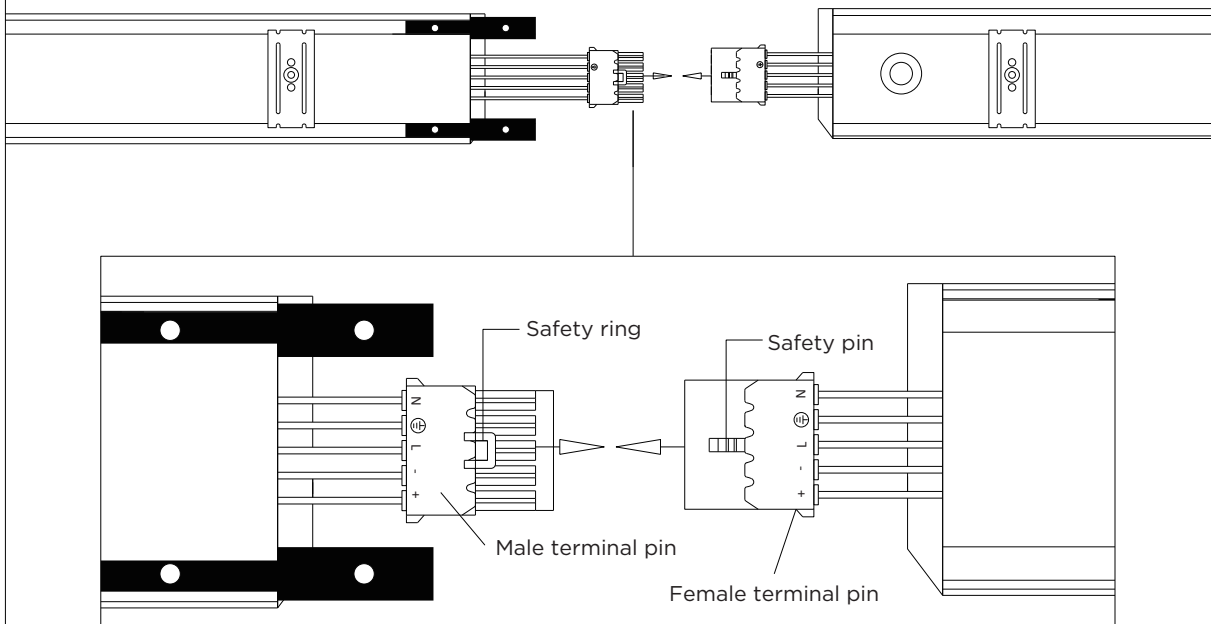

Insert the male terminal pins into the slots of the female terminals, then allow the safety pin to snap tightly onto the safety ring.

4

LIGHT TO LIGHT CONNECTION

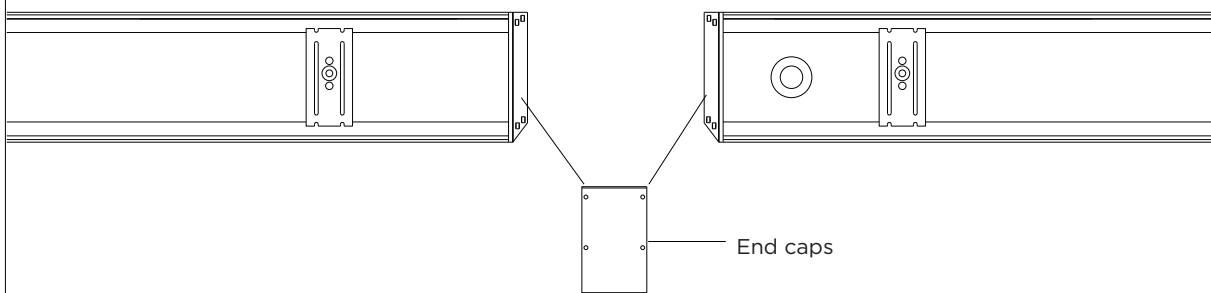

Remove the end caps at both ends of the tandem connection.

Put the iron bar into the grooves on both sides of the aluminum tube, turn the screws into the teeth holes with a screwdriver, and lock it in place.

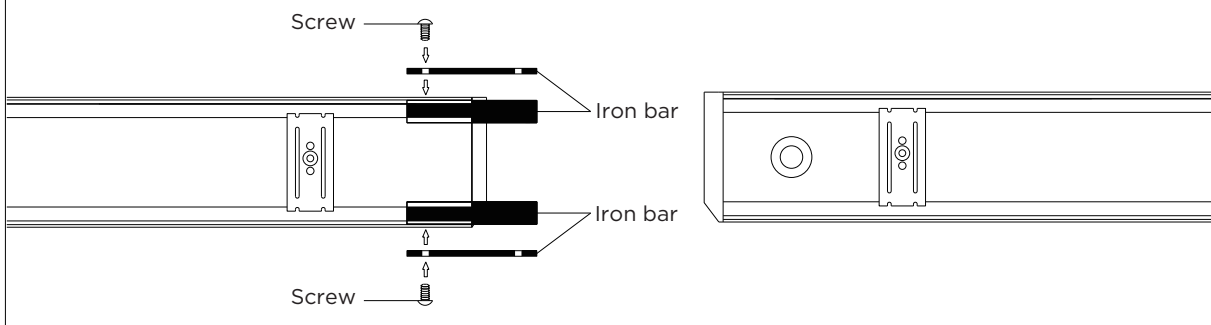

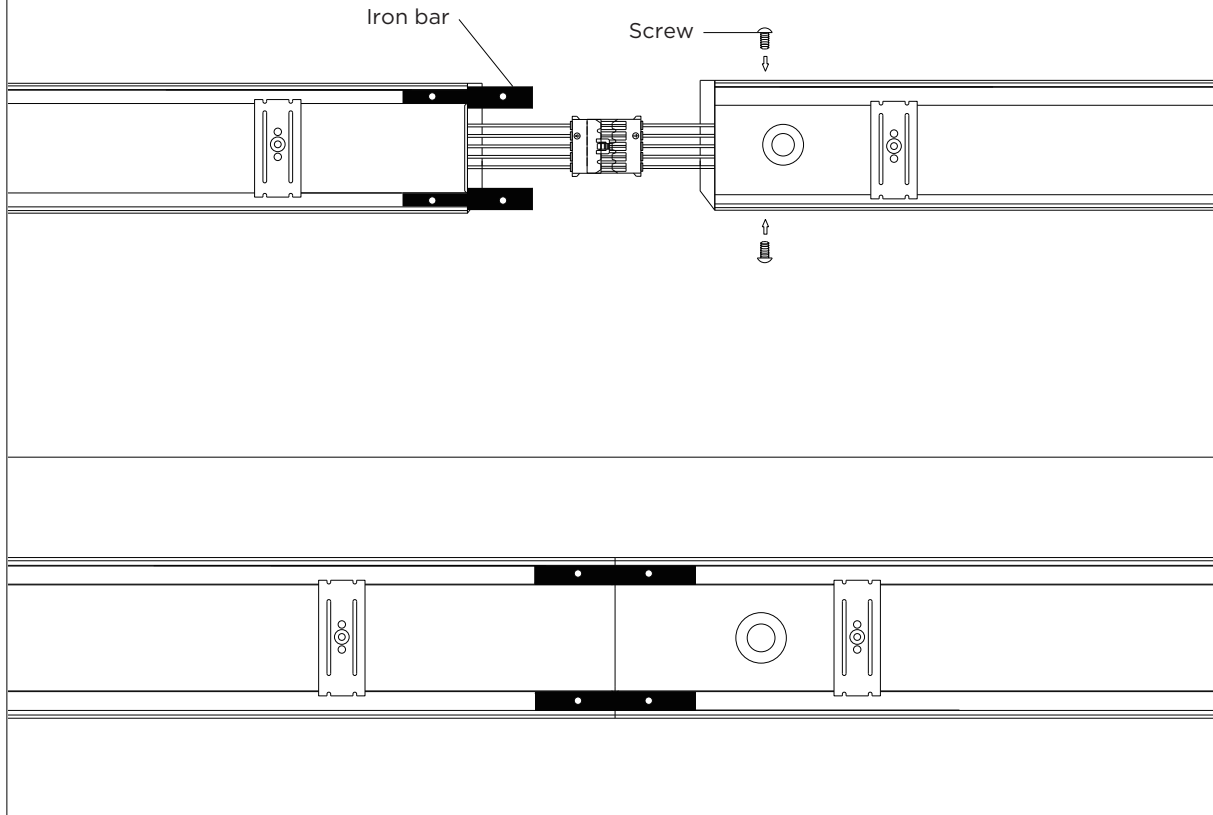
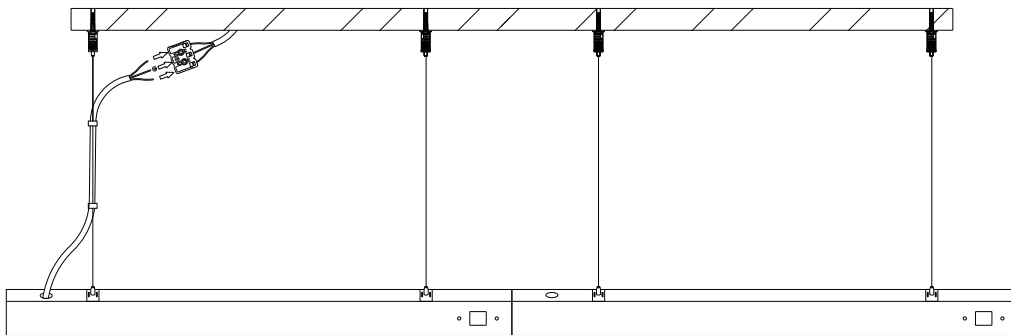
5**LIGHT TO LIGHT CONNECTION****6****LIGHT TO LIGHT CONNECTION**

When connected in series, the assembled luminaires are powered with a single electrical connection. The length of the wire rope can be adjusted by pressing the small cylindrical part at the end of the tensioning head and pushing it upwards.